



比亚迪  
半导体

BOS-0603TC

# PRODUCT SPECIFICATION

**Model No: BOS-0603TC**

For reference only.

Subject to change maybe necessary in a limited number of cases

## Descriptions:

- **Miniature Surface Mounted Chip LED**
- **Upward-lightning And Surface Mounted Type (0603 Package)**
- **Emitting Color :                   Yellow-Green**
- **Viewing Angle :                       120°**



CUSTOMER APPROVED SIGNATURES	APPROVED BY	CHECKED BY	PREPARED BY
	Zheng.maoling	Lin.yankai	Liao.bin

Address: Xiangshui River, Economic

地址: 广东省惠州市大亚湾响水河 (516083)

Development Zone, Daya Bay, Huizhou,  
Guangdong, 516083 P.R. China

电话: +86-755-89888888; +86-752-5118888

http: // [www.byd.com.cn](http://www.byd.com.cn)

**■ Applications**

- Mobile Phone,
- Back\_light
- Indicator...

**■ Device Selection Guide**

Model No.	Chip		Epoxy Color
	Material	Emitting Color	
<b>BOS-0603TC</b>	AlGaInP	Yellow-Green	Clear

**■ Package Outline Dimensions**

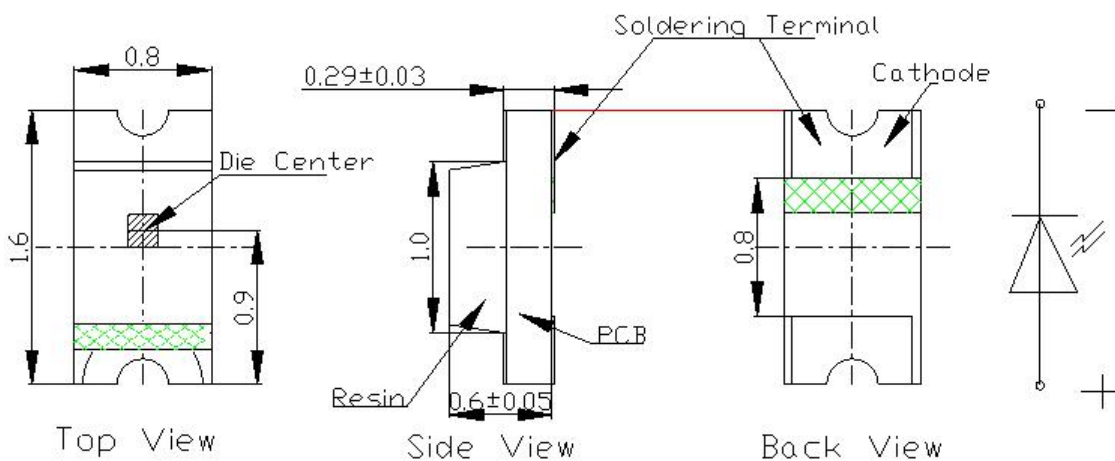

Notes:

All dimensions in mm  
tolerance  $\pm 0.1$ mm  
unless otherwise noted

Recommended Soldering Pad

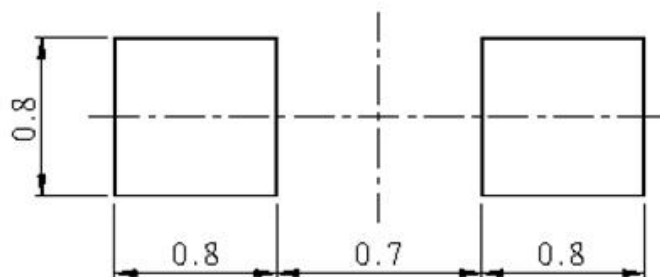



■ Absolute Maximum Ratings(Ta=25° C)

Items	Symbol	Absolute Maximum Ratings	Unit
Power Dissipation	P <sub>d</sub>	45	mW
Forward Current(DC)	I <sub>F</sub>	20	mA
Peak Forward Current*	I <sub>FP</sub>	100	mA
Reverse Voltage	V <sub>R</sub>	5	V
Operation Temperature	T <sub>opr</sub>	-40 ~ +80	°C
Storage Temperature	T <sub>stg</sub>	-40 ~ +100	°C
Electrostatic Discharge	ESD	2000	V
Lead Soldering Temperature	T <sub>sol</sub>	260°C for 5 Seconds	

\*Pulse Width  $\leq 0.1\text{msec}$  and Duty  $\leq 1/10$

■ Typical Electrical & Optical Characteristics (Ta=25°C)

Items	Symbol	Condition	Min.	Typ.	Max.	Unit
Forward Voltage	V <sub>F</sub>	I <sub>F</sub> =20mA	1.8	2.0	2.6	V
Reverse Current	I <sub>R</sub>	V <sub>R</sub> =5V	---	---	10	μA
Dominant Wavelength	λ <sub>D</sub>	I <sub>F</sub> =20mA	564	568	574	nm
Luminous Intensity	I <sub>v</sub>	I <sub>F</sub> =20mA	45	75	---	mcd
50% Power Angle	2θ <sub>1/2</sub>	I <sub>F</sub> =20mA	---	120	---	deg

■ Forward Voltage Rank Limits ( I<sub>F</sub> =20mA )

Code	Min	Max	Unit
18	1.8	2	V
20	2	2.2	
22	2.2	2.4	
24	2.4	2.6	

■ Luminous Intensity Rank Limits( I<sub>F</sub> =20mA )

Code	Min	Max	Unit
D0	18	28	mcd
E0	28	45	
F0	45	72	
G0	72	113	

■ Dominant Wavelength Rank Limits ( I<sub>F</sub> =20mA )

Code	Min	Max	Unit
E	564	566	nm
F	566	568	
G	568	570	
H	570	572	
I	572	574	

- Notes: 1.Tolerance of measurement of forward voltage is  $\pm 0.05\text{V}$  ;  
 2. Tolerance of measurement of luminous intensity is  $\pm 10\%$ ;  
 3. Tolerance of measurement of dominant wavelength is  $\pm 1.0\text{nm}$

**Note: For long-term performance, the drive currents between 1 mA and 20 mA are recommended. If the drive currents is different with our condition ,Please contact our customer service.**



### ■ Typical Electrical / Optical Characteristics Curves (Ta = 25°C Unless Otherwise Noted)

Fig.1 Forward Current vs. Forward Voltage

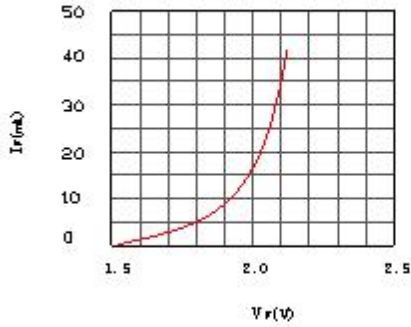

Fig.2 Relative Luminous Intensity vs. Forward Current

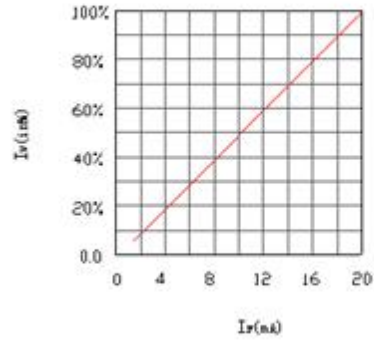

Fig.4 Relative Luminous Intensity vs. Ambient Temperature

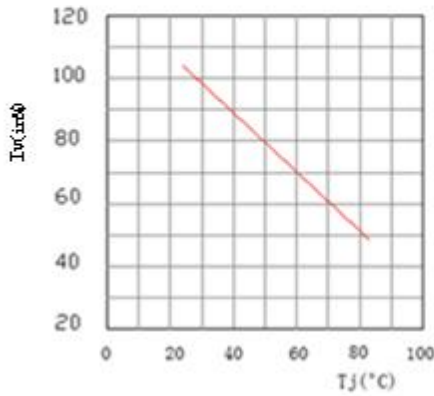

Fig.3 Relative Luminous Intensity vs. Wavelength

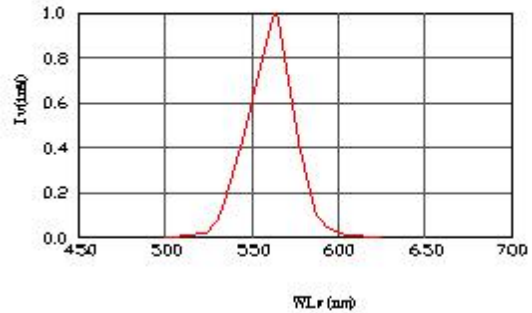

Fig.5 Maximum Forward Current vs. Ambient Temperature

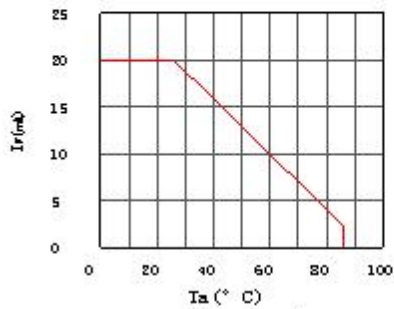
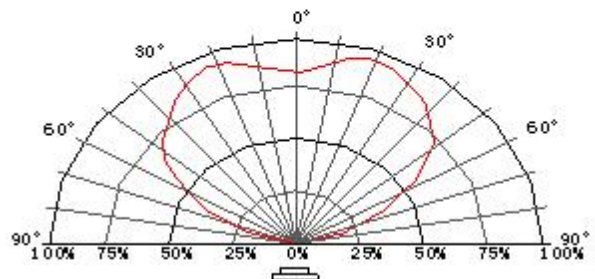

Fig.6 Relative Luminous Intensity vs. Radiation Angle





### ■ Packing Specification

1. Packing Type: Reel and Anti-electrostatic Bag
2. Packing Standard Quantity: 4000pcs/Reel, 40kpcs/box.  
Note: The same Rank LED should be in the same box.

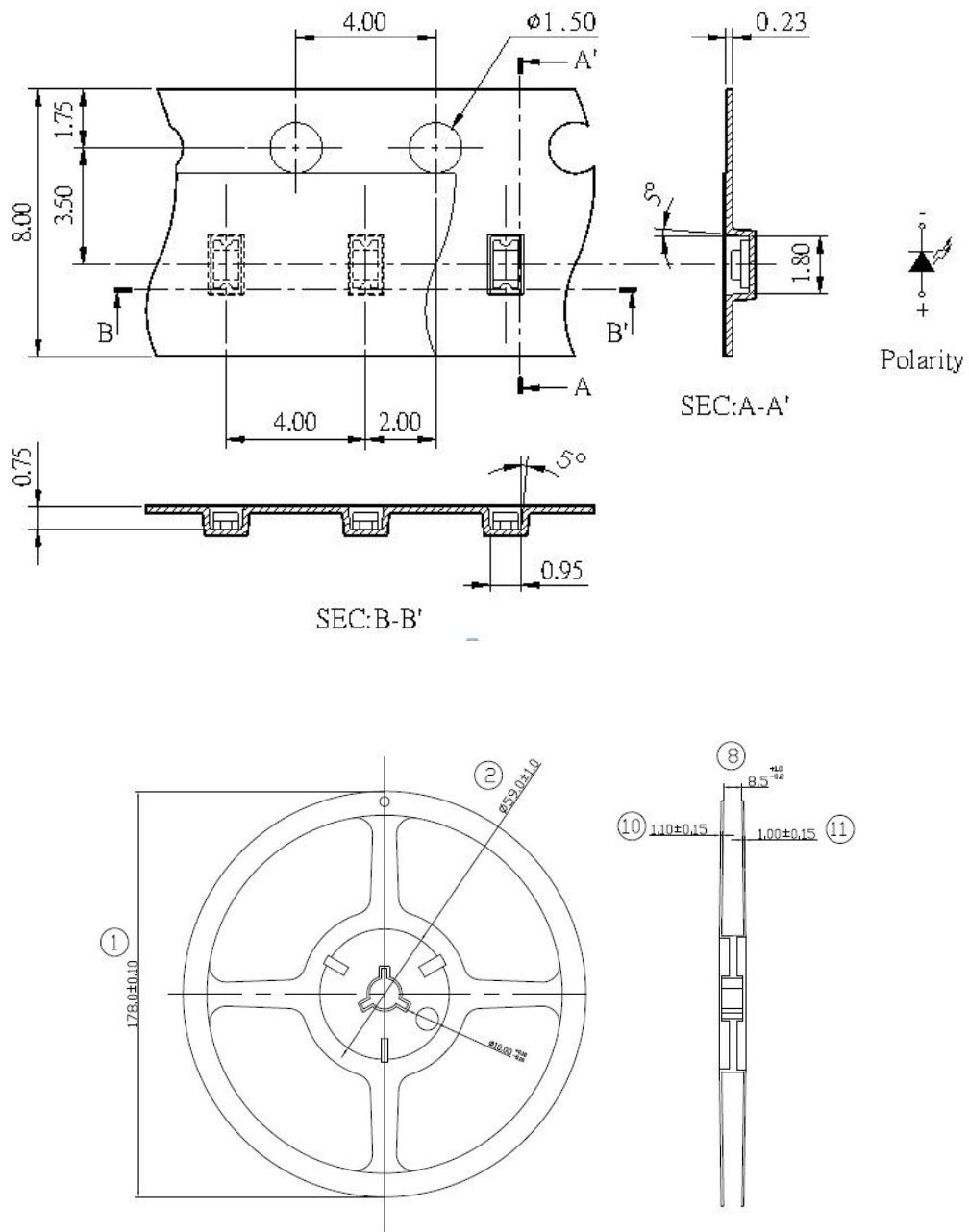

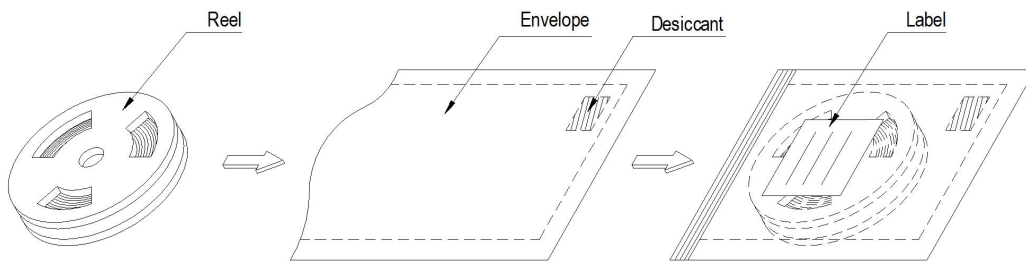

3. Label Form

DIVISION VI LED Factory																													
<b>BOS-0603TC</b>																													
SAP NO: [Barcode]	<table border="1"> <thead> <tr> <th colspan="3">LED烘烤标识</th> </tr> <tr> <th>产品型号</th> <td></td> <td></td> </tr> <tr> <th>客户料号</th> <td></td> <td></td> </tr> <tr> <th></th> <th>日期/时间</th> <th>责任人</th> </tr> </thead> <tbody> <tr> <td>拆封</td> <td></td> <td></td> </tr> <tr> <td>烘烤1</td> <td></td> <td></td> </tr> <tr> <td>取料1</td> <td></td> <td></td> </tr> <tr> <td>烘烤2</td> <td></td> <td></td> </tr> <tr> <td>取料2</td> <td></td> <td></td> </tr> </tbody> </table>		LED烘烤标识			产品型号			客户料号				日期/时间	责任人	拆封			烘烤1			取料1			烘烤2			取料2		
LED烘烤标识																													
产品型号																													
客户料号																													
			日期/时间	责任人																									
拆封																													
烘烤1																													
取料1																													
烘烤2																													
取料2																													
LOT NO: [Barcode]																													
VF(V): [Barcode]																													
IV(mcd): [Barcode]																													
WD (nm) [Barcode]																													
Q'ty(pcs) [Barcode]																													
20mA CODE:	QA Date:																												
Made in China																													

Notes:

- SAP NO. :BYD Products Number
- Custom P/N:Custom Molde Number
- Q'TY: Packing Quantity
- IV: Luminous Intensity
- VF: Forward Voltage
- WD: Dominant Wavelength



■ Reliability

1) Test Items and Results:

Classification	Test Item	Standard Test Method	Test Conditions	Duration	Units Tested	Number Of Damaged
Life Test	Operating Life Test	JIS7021:B4 MIL-STD-202:107D MIL-STD-750:1026	Ta=25°C±5°C,IF=20mA	1000 Hrs	22	0/22
Environment Test	High Temperature Storage	JIS7021:B10 MIL-STD-202:210A MIL-STD-750:2031	Ta=85°C±5°C	1000Hrs	22	0/22
	Low Temperature Storage	JIS7021:B12	Ta=-40°C±5°C	1000Hrs	22	0/22
	Temp. & Humidity Test	JIS7021:B11 MIL-STD-202:103D	Ta=85°C±5°C RH=85%±5%RH	1000 Hrs	22	0/22
	Thermal Shock Test	JIS7021B4 MIL-STD-202:107D MIL-STD-750:1026	-10°C ← - → 80°C 5min 10sec 5min	100 Cycles	22	0/22
	Temperature Cycling Test	JIS7021:A3 MIL-STD-202:107D MIL-STD-705:1051	-40°C ~ 25°C ~ 80°C 15min 5min 15min	100 Cycles	22	0/22
Soldering Test	Resistance to soldering		Tsol=260±5°C, 10sec	1 time	22	0/22

2) Criteria for Judge The Damage:

Items	Symbol	Condition	Criteria for Judge	
			Min.	Max.
Forward Voltage	V <sub>F</sub>	I <sub>F</sub> =20mA	---	initial value x 1.1
Reverse Current	I <sub>R</sub>	V <sub>R</sub> =5V	---	initial value x 1.1
Luminous Intensity	I <sub>V</sub>	I <sub>F</sub> =20mA	initial value x 0.7	---

## ■ Precautions For Use

### 1. Over –current –proof

Customer must apply resistors for protection, otherwise slight voltage shift will cause big current change (Burn out will happen)

### 2. Storage Caution

2.1 The storage condition in sealed bags: at 5-35 °C and <70% relative humidity.

2.2 After bags are opened, the devices must be mounted within 24 hrs at <60% relative humidity.

2.3 It will be better to bake all devices before soldering.

2.4 Devices must be baked before mounting, if

A, the color of humidity indicator card at point “>30%” is pink (the original color is blue);

B, the devices will be soldered over 2 times (including 2 times);

C, bags are opened over 24 hrs.

D. the stroge time (begin with QA date ) is over 3 months.

2.5 The bake condition: 24 hrs at 65 °C ±5 °C ( 12-48 hrs will be available if 24 is not suitable )

### 3. Reflow Soldering / Time

#### 3.1 Lead Solder/Time

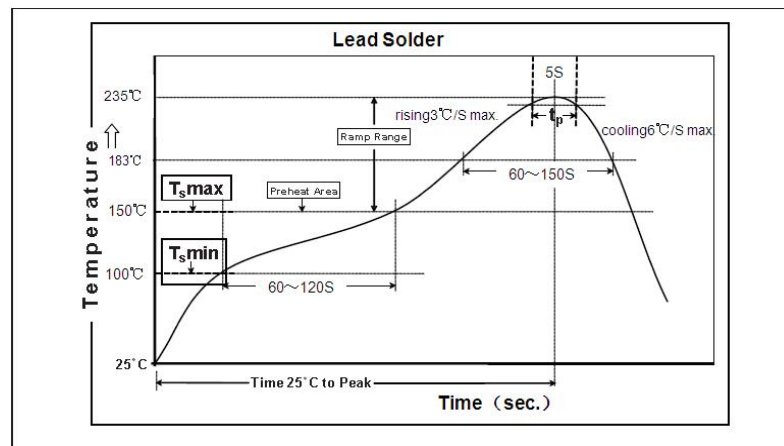

#### 3.2 Lead-free Solder/Time

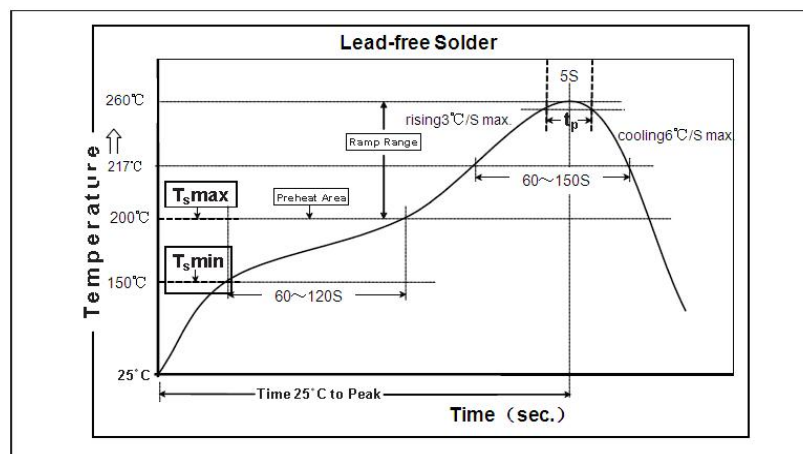



#### 4. Soldering Iron

- 4.1 When hand soldering, keep the temperature of iron below less 300°C less than 3 seconds
- 4.2 The hand solder should be done only one times
- 4.3 The basic spec is  $\leq 5$  sec. when the temperature of 260°C, do not contact the resin when hand soldering

#### 5. Rework

- 5.1. Customer must finish rework within 5 sec. under 260°C
- 5.2. The head of iron can not touch the resin
- 5.3. Twin-head type is preferred.

#### 6. Control method of LED devices Usage

1). Before baking, it is necessary to fill in the baking form that including detail information such as model and lot number of devices, starting and ending time of baking, operators, etc. Devices that have longest dehumidify time should be used previously for those baked over 24 hrs. LED products that will not use immediately should be vacuum sealed when the baking time is almost 72hrs. Devices must be baked before next soldering.

2). The baked devices must be mounted within 24 hrs. Devices each time get out from the oven should be mounted in 4 hrs.

3). Devices must be baked 24hrs at  $65 \pm 5$  °C if the exposure time is between 24hrs and 48 hrs. Bulk devices must be baked 12hrs at 125 °C in metal plate if the exposure time is over 48 hrs.

4). The soldering interval should be less than 24hrs if the PCB with devices will be SMT for two times. PCB with devices must be baked 24 hrs at  $65 \pm 5$  °C if the interval of two SMT is between 24hrs and 48hrs. Or PCB with devices must be baked 12 hrs at 100 °C to 125 °C if the interval of two SMT is between 24hrs and 48hrs.

#### 7. Caution in ESD

- 7.1 Electrostatic discharge (ESD) and surge current (EOS) can damage LEDs.
- 7.2 An ESD wrist strap, ESD shoe strap or antistatic gloves must be worn whenever handling LEDs
- 7.3 All devices equipment and machinery must be properly grounded.

#### 8. RESTRICTIONS ON PRODUCT USE

- The information contained herein is subject to change without notice.
  
- **BYD Semiconductor Company Limited** exerts the greatest possible effort to ensure high quality and reliability. Nevertheless, semiconductor devices in general can malfunction or fail due to their inherent electrical sensitivity and vulnerability to physical stress. It is the responsibility of the buyer, when utilizing products, to comply with the standards of safety in making a safe design for the entire system, including redundancy, fire-prevention measures, and malfunction prevention, to prevent any accidents, fires, or community damage that may ensue. In developing your designs, please ensure that products are used within specified operating ranges as set forth in the most recent products specifications.

- The products listed in this document are intended for usage in general electronics applications (computer, personal equipment, office equipment, measuring equipment, industrial robotics, domestic appliances, etc.). These products are neither intended nor warranted for usage in equipment that requires extraordinarily high quality and/or reliability or a malfunction or failure of which may cause loss of human life or bodily injury (“Unintended Usage”). Unintended Usage include atomic energy control instruments, airplane or spaceship instruments, transportation instruments, traffic signal instruments, combustion control instruments, medical instruments, all types of safety devices, etc.. Unintended Usage of products listed in this document shall be made at the customer’s own risk.